

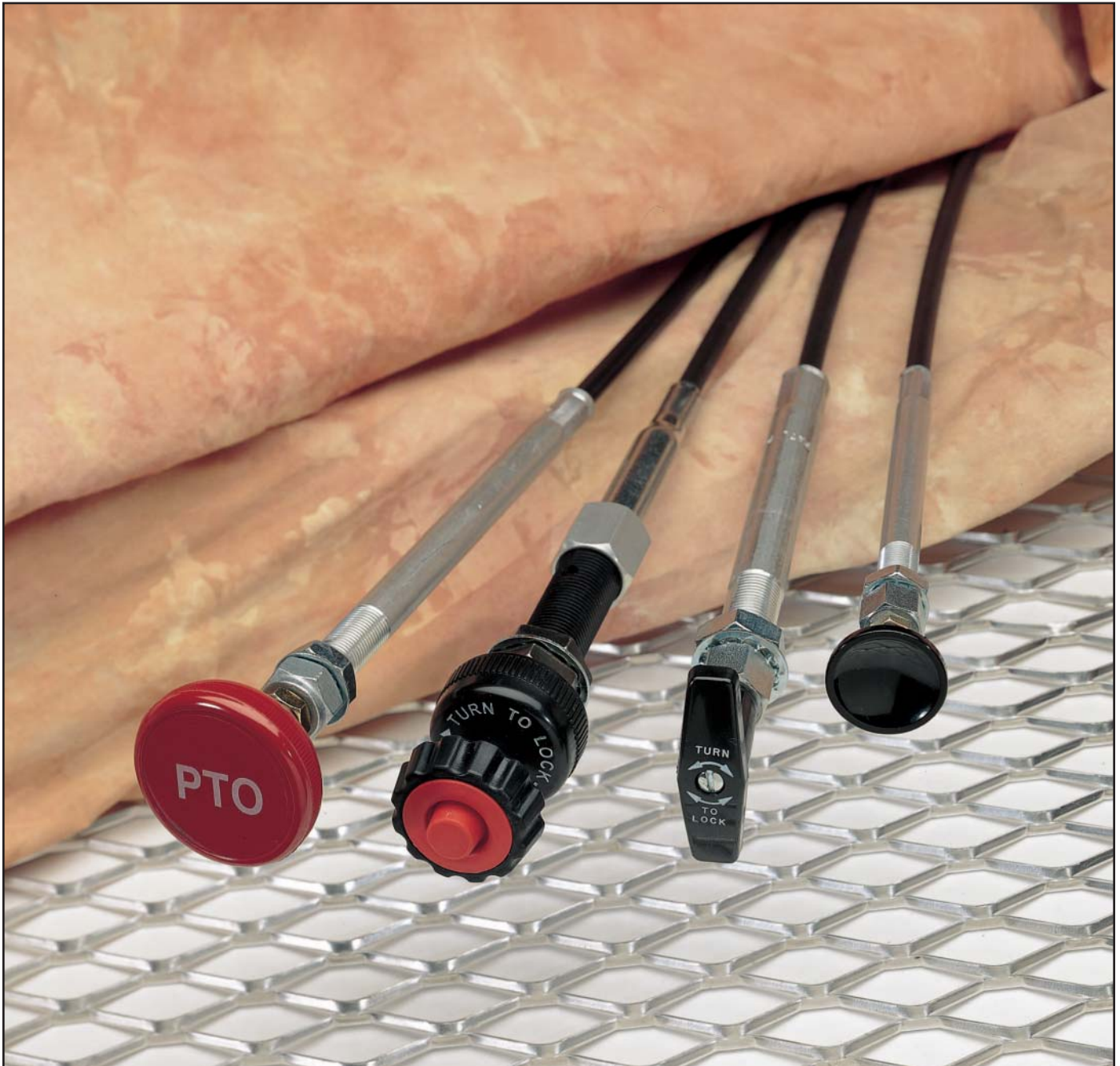

ISO 9001 CERTIFIED

PANEL CONTROL SYSTEMS



WESCON CONTROLS

WESCON'S PANEL CONTROL SYSTEMS



Power Take-Off (PTO) Control Systems

Developed for harsh environment applications where remote PTO shifting is done. With rugged polymer conduit cover, .085 diameter stainless steel solid core and easy to grip phenolic knob, this control will give you the performance needed for your demanding applications. See pages 4 and 5 for options for this control.



Vernier Control Systems

Developed for applications where a precise setting is required, such as engine RPM's or pump pressure. See pages 6 & 7 for options for this control.



Non-Locking Control Systems

Developed for hand actuated remote operation of light to moderate loads such as valves, chokes, engine throttles and shut-offs. These controls provide smooth and easy operation and are designed to be long lasting. See pages 10, 11 & 12 for options for this control.



Turn-To-Lock Control Systems

Developed for applications where severe vibration may occur. Used in operating chokes, throttles, engine shut-offs and valves where a positive lock is needed. See pages 8 & 9 for options for this control.



Output Ends

Wescon offers a number of different options for the output ends of your panel controls. Swivel ends, utility ends or field installed kits are all available to meet your specific needs.



Accessories

Wescon's Accessories offer a wide variety of end terminations and mounting variations. See pages 14 and 15 for available accessories.

Conduit

Wescon's Long-Lay Conduit Construction

Wescon's long-lay conduit consists of multiple strand wire design of oil-tempered carbon spring steel wire. It withstands high tension and compression with minimum deflection under load and superior protection for the load carrying core wire.

The conduit life of Wescon cables is extraordinary because of tough polyethylene covers. These covers seal out environmental contaminants and dirt while resisting abrasion and common solvents. The cover design stands up to exposure to sunlight and temperature extremes ranging from -65° to +225° F. Optional nylon and other plastics may be requested to suit your environmental or high temperature applications.

Wescon's Binder-Wrapped Conduit Construction

An option to the long-lay conduit construction is the flat steel binder-wrapped conduit. This construction is desirable in applications requiring higher compression loading of the conduit.

Wescon's Maximum Efficiency Liners

Specially formulated High Density Polyethylene liners (as well as special formulations for high temperature applications) minimize friction for maximum efficiency. The inside diameter is precisely controlled, minimizing lost motion and premature wear.

Wescon's Corrosion Resistant Design

All standard conduit fittings are plated steel. Guide tubes are nickel-plated brass. End rods are stainless steel for corrosion resistance. In addition, all bulk-packed Wescon cables are furnished with protective vinyl caps installed over threads to prevent damage during shipment and handling. Stainless steel conduit fittings and mounting hardware are available for marine and other demanding applications.

Inner-Core

Wescon's Core Wire

Wescon's core wire choices include: (1) Armor Core - Stainless steel flat wire swaged over galvanized steel stranded cable and burnished to a smooth, close tolerance finish or (2) Solid stainless steel wire. (3) Nylon covered 1 x 7 core for 40 Series Turn-to-Lock and Vernier only. These designs combine high column strength and a smooth, low friction finish.

Lubrication

Special formulated lubricants are factory installed along the length of the control cable and in areas of excessive wear for years of maintenance-free, high efficient operation.

Wescon's Super Rod Seals

Wescon's special custom molded SUPER SEAL design assures a smooth cable operation. The seals, in conjunction with our fine finish 303 stainless steel rods, reduce contamination and corrosion by keeping foreign materials (such as dirt and moisture) off the bearing surfaces. This mating of the SUPER SEAL with the superior rod finish results in a longer cable life without sacrificing efficiency. This design provides superior protection at no additional charge.

Input Loads

To calculate Input Loads for Wescon Push-Pull Cables, use the following formula and chart:

$$\text{Input Load (lbs)} = \text{Output Load (lbs)} \times \text{Efficiency Factor}$$

| Degrees Bend | Efficiency Factor * (std. liner only) |
|--------------|--|
| 90° | 1.2 |
| 180° | 1.4 |
| 270° | 1.6 |
| 360° | 1.8 |

* Efficiency factors may vary depending on Input load, total degree of bend and number of cycles desired.

Specifications contained herein are subject to change without notice

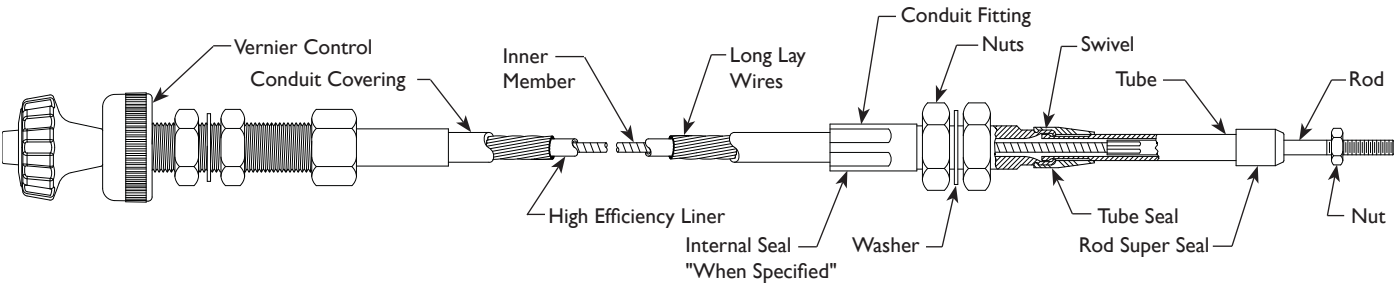

MICRO ADJUSTABLE VERNIER CONTROL

STANDARD DESIGN INCLUDES:

- Two Piece Construction
- Black Long Lay Conduit
- Includes Friction Locknut and Red Push Button Cover
- 3" Travel with .085 S.S.Wire
- Can be Cut to Length in the Field (See Field Installation Kits Pg. 16)
- Individually Packaged
- Max Recommended Working Load 25 Lbs.

| Part Number | Length |
|----------------|--------------|
| 953A02-BIS060I | 5 Feet Long |
| 953A02-BIS120I | 10 Feet Long |
| 953A02-BIS180I | 15 Feet Long |
| 953A02-BIS240I | 20 Feet Long |
| 953A02-BIS300I | 25 Feet Long |
| 953A02-BIS360I | 30 Feet Long |

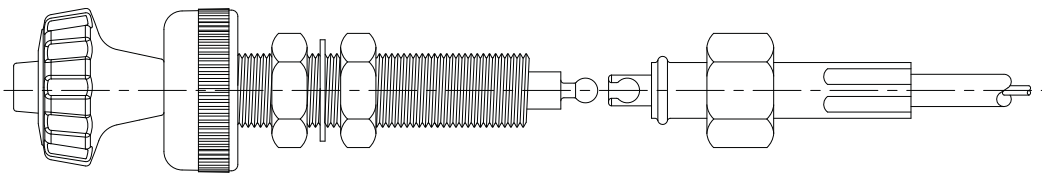

PTO CONTROL

STANDARD DESIGN INCLUDES:

- Double Wound Bowden Conduit for Greater Flexibility and Strength
- Red Phenolic Knob with "PTO" in White Shipped in Bulk
- 5" Travel with .085 S.S.Wire
- Includes Conduit Clamp Kit (01-5000-09)
- Individually Packaged

| Part Number | Length |
|----------------|--------------|
| 9761K-B3S-060I | 5 Feet Long |
| 9761K-B3S-120I | 10 Feet Long |
| 9761K-B3S-180I | 15 Feet Long |
| 9761K-B3S-240I | 20 Feet Long |
| 9761K-B3S-300I | 25 Feet Long |
| 9761K-B3S-360I | 30 Feet Long |

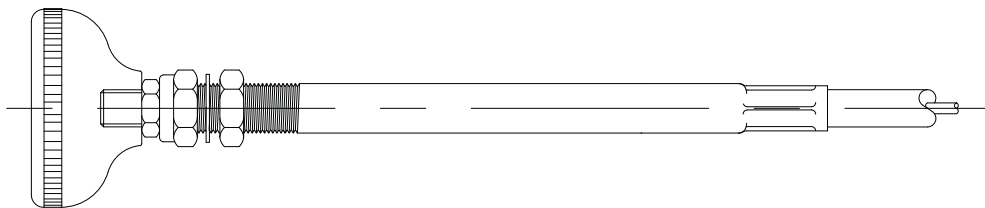

Built rugged for long service life and efficient operation in harsh environments. Options include various colors, brands of knobs and conduits.

**Available in 30 series long lay or double wound conduit only.
5" travel only.**

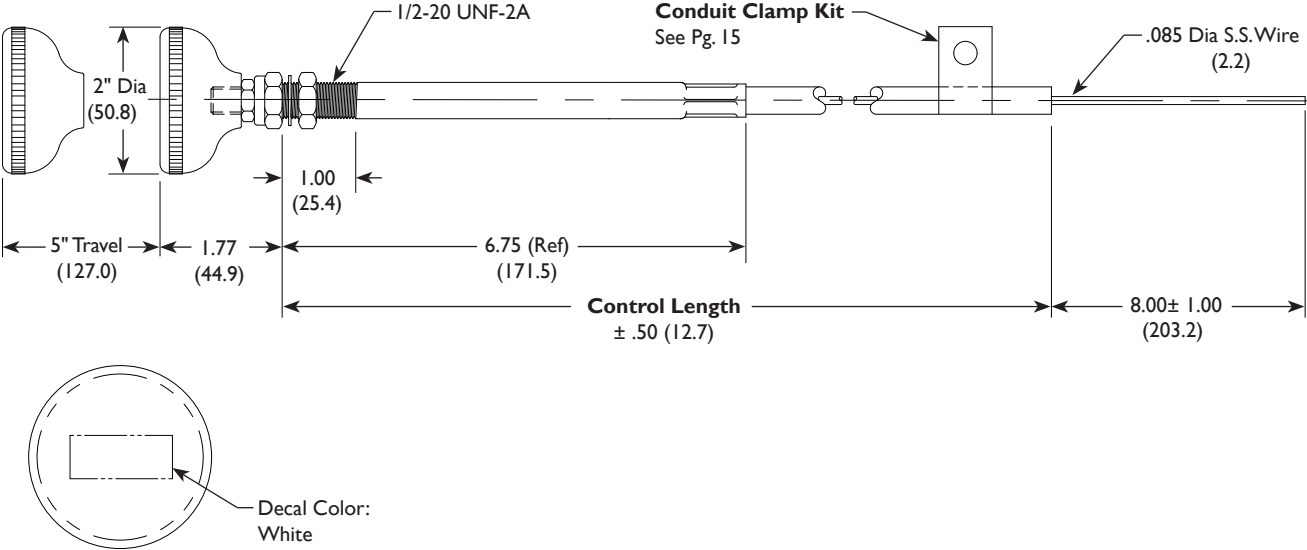

Part No. Code - "Custom" PTO Controls

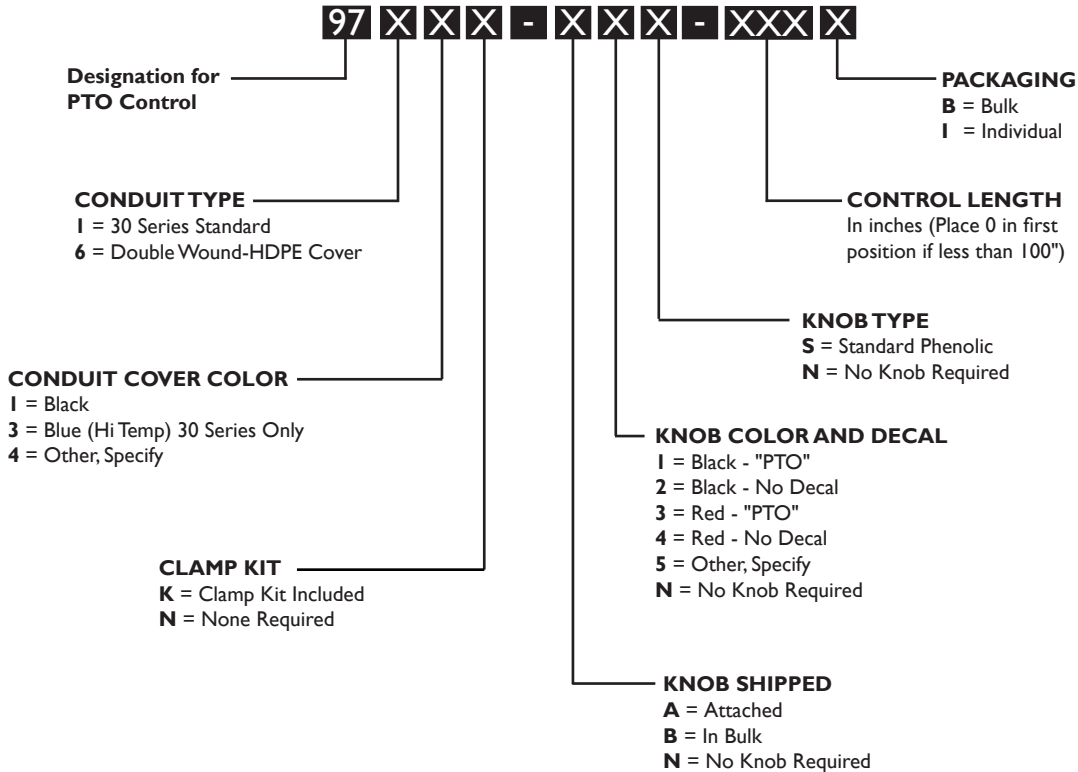

30 SERIES VERNIER CONTROL

STANDARD CONSTRUCTION INCLUDES:

- .085 (2.2) Dia. Stainless Steel Wire
- .31 (7.9) Dia. Conduit
- 3" Travel in Head End
- 1", 2" or 3" Travel @ Swivel End (3" Travel Standard)
- Max Recommended Working Load 25 Lbs.

These controls are designed for use in applications where extremely precise settings, such as engine RPM's, are required. The “Red Button” in the center of the knob allows for “Coarse Adjustment”. It also doubles as an “Emergency Button”, by depressing it, you can return the Vernier to idle position in one quick stroke. The black outer portion of the knob is used for fine adjustment. The standard friction knob locks the control, totally eliminating creep. The fully threaded high strength composite body and internal lock ball design (which is captured and cannot fall out) provides increased load range and extended plunger life. The head can be disconnected to allow for easy installation of the Vernier by removing one nut.

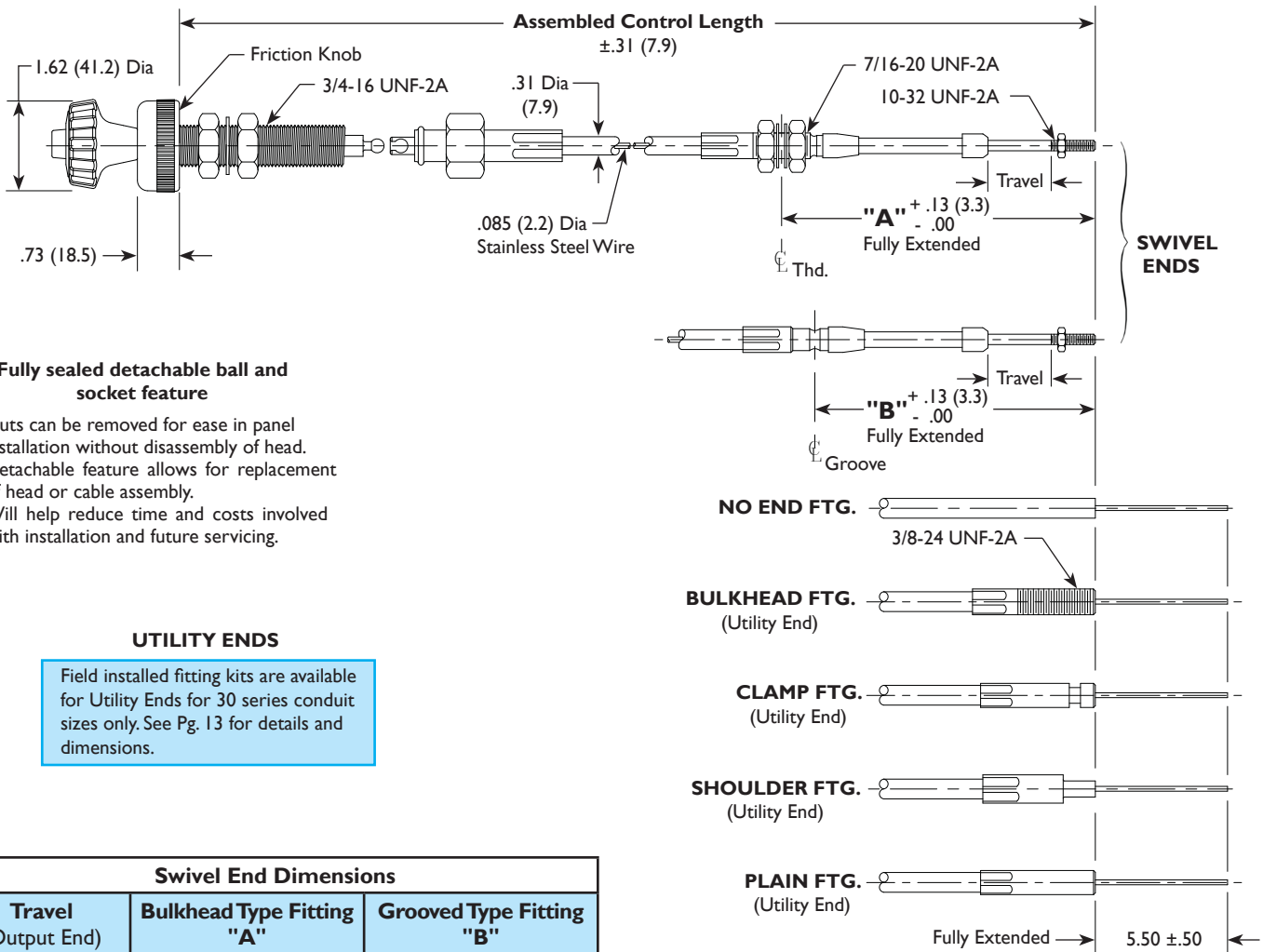

Fully sealed detachable ball and socket feature

- Nuts can be removed for ease in panel installation without disassembly of head.
- Detachable feature allows for replacement of head or cable assembly.
- Will help reduce time and costs involved with installation and future servicing.

UTILITY ENDS

Field installed fitting kits are available for Utility Ends for 30 series conduit sizes only. See Pg. 13 for details and dimensions.

| Swivel End Dimensions | | |
|-----------------------|---------------------------|--------------------------|
| Travel (Output End) | Bulkhead Type Fitting "A" | Grooved Type Fitting "B" |
| 1" (25.4) | 4.88 (123.9) | 4.30 (109.2) |
| 2" (50.8) | 6.87 (174.5) | 6.31 (160.3) |
| 3" (76.2) | 8.88 (225.6) | 8.30 (210.8) |

40 SERIES VERNIER CONTROL

STANDARD CONSTRUCTION INCLUDES:

- .125 (3.2) Dia. Armor Wrap Core
- .44 (11.2) Dia. Conduit
- 3" Travel in Head End
- 1", 2" or 3" Travel @ Swivel End (3" Travel Standard)
- Max Recommended Working Load 25 Lbs.

| Swivel End Dimensions | | |
|-----------------------|---------------------------|--------------------------|
| Travel (Output End) | Bulkhead Type Fitting "A" | Grooved Type Fitting "B" |
| 1" (25.4) | 5.13 (130.3) | 4.50 (114.3) |
| 2" (50.8) | 7.13 (181.1) | 6.50 (165.1) |
| 3" (76.2) | 9.13 (231.9) | 8.50 (215.9) |

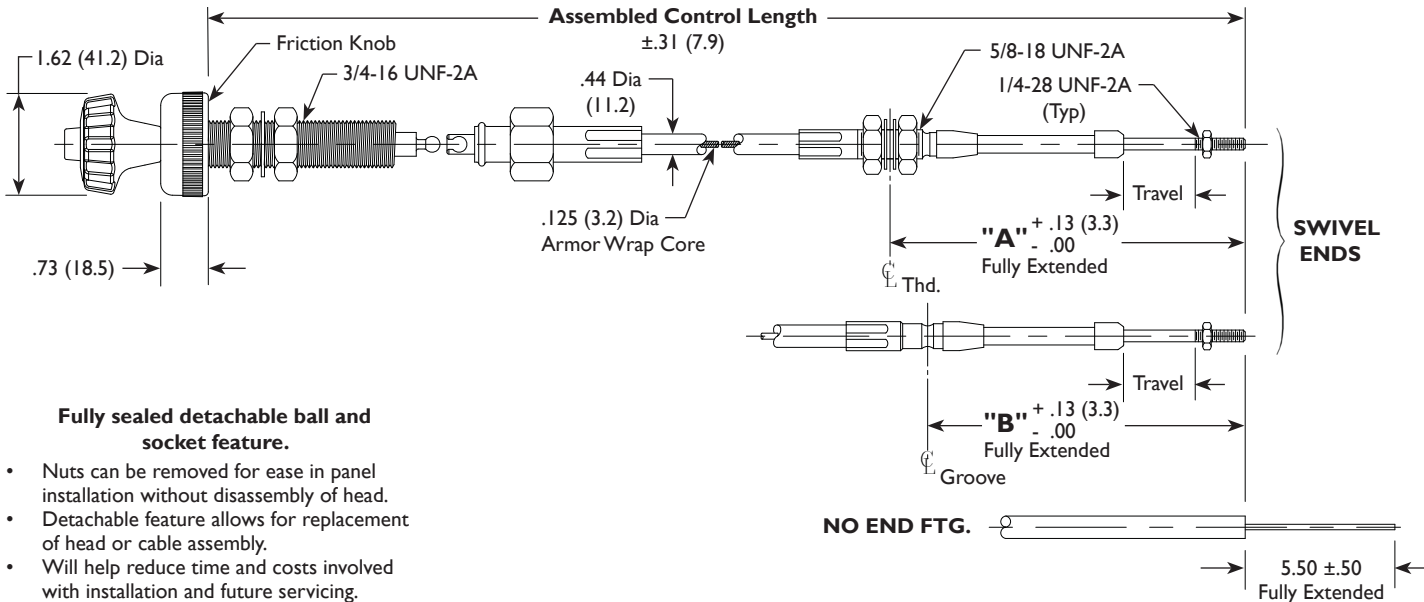

Fully sealed detachable ball and socket feature.

- Nuts can be removed for ease in panel installation without disassembly of head.
- Detachable feature allows for replacement of head or cable assembly.
- Will help reduce time and costs involved with installation and future servicing.

Part No. Code - "Custom" Vernier Controls

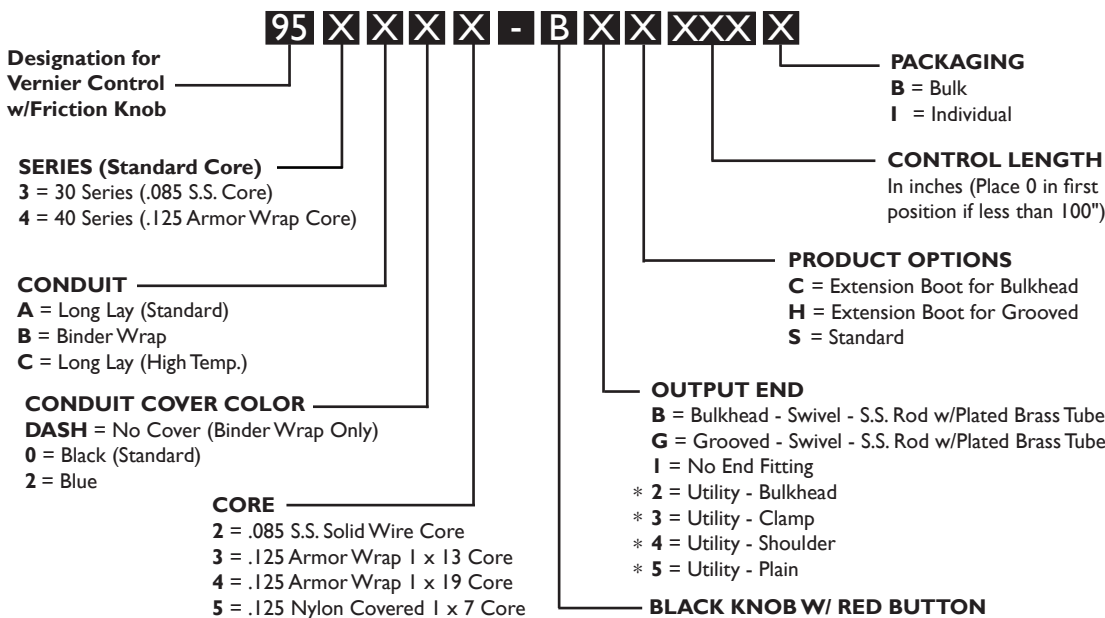

* Not available in 40 Series

20 SERIES CONTROL

STANDARD CONSTRUCTION INCLUDES:

- .062 (1.6) Dia. Stainless Steel Wire
- .25 (6.4) Dia. Conduit
- 3" or 5" Travel @ Handle End
- 2" or 3" Travel @ Swivel End

30 SERIES CONTROL

STANDARD CONSTRUCTION INCLUDES:

- .085 (2.2) Dia. Stainless Steel Wire
- .31 (7.9) Dia. Conduit
- 3" or 5" Travel @ Handle End
- 2", 3", 4" or 5" Travel @ Swivel End
- 30 Series is Wescon's Standard Turn-To-Lock Control System

These controls are designed for use in applications where severe vibration may occur. By turning the "T" Knob either clockwise or counterclockwise the new Turn-To-Lock design will withstand vibration and has the capacity to hold greater loads than competitive designs. Unlike other designs, we have no metal to metal contact, thereby reducing wear in the unit. The control head is available in 3 or 5 inch travels which can accommodate a 1 to 5 inch travel at the output end. Wescon's new patented Turn-To-Lock control requires less torque to lock and unlock, has a rod seal to keep out contaminants and is temperature tested for a wide range of applications.

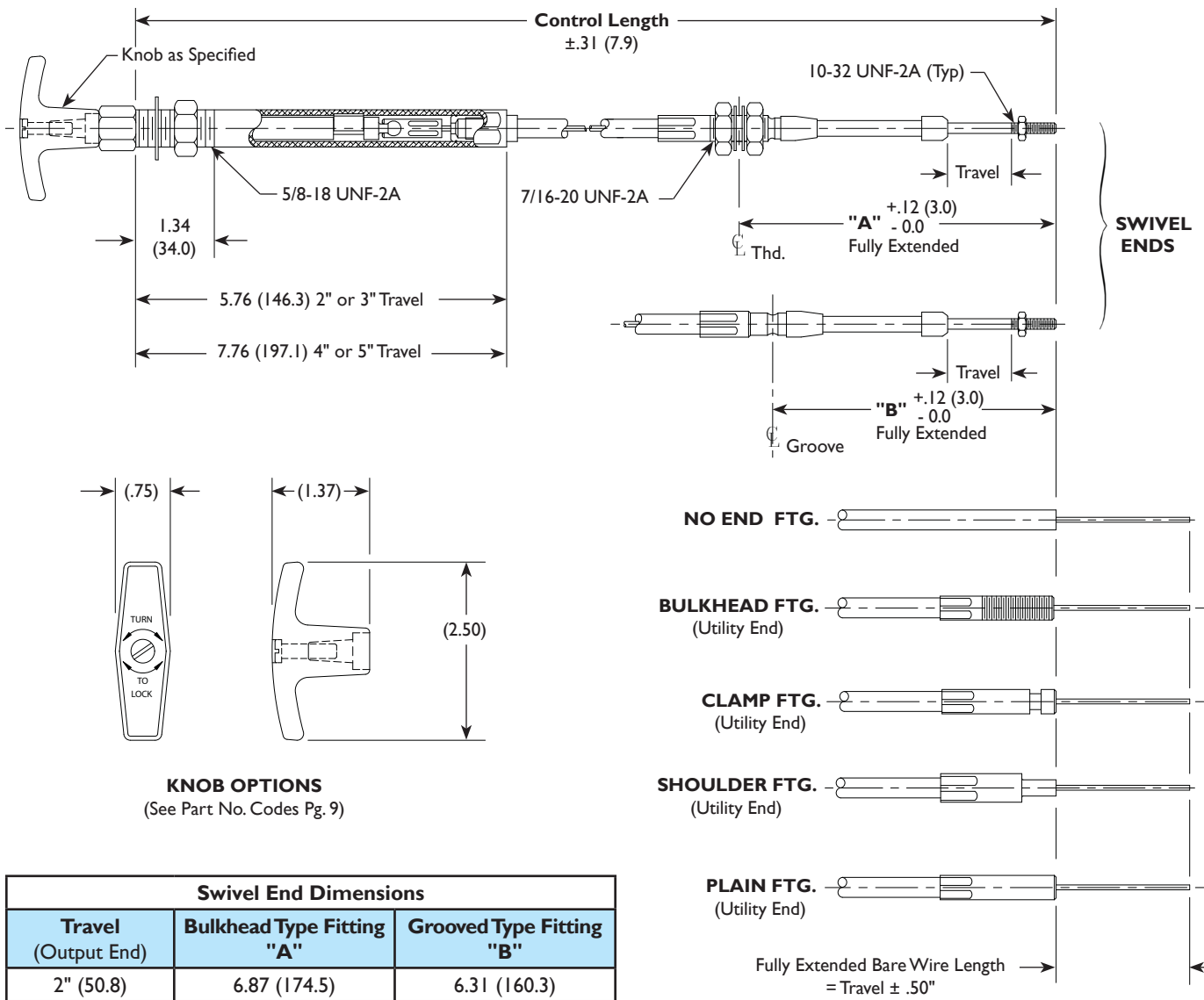

KNOB OPTIONS
(See Part No. Codes Pg. 9)

| Swivel End Dimensions | | |
|-----------------------|---------------------------|--------------------------|
| Travel (Output End) | Bulkhead Type Fitting "A" | Grooved Type Fitting "B" |
| 2" (50.8) | 6.87 (174.5) | 6.31 (160.3) |
| 3" (76.2) | 8.88 (225.6) | 8.30 (210.8) |
| 4" (101.6) | 10.87 (276.1) | 10.31 (261.9) |
| 5" (127.0) | 12.88 (327.1) | 12.30 (312.4) |

All Dimensions are Inches (mm)

UTILITY ENDS
Field installed fitting kits are available for Utility Ends for 30 series conduit sizes only. See Pg. 13 for details and dimensions.

40 SERIES CONTROL

STANDARD CONSTRUCTION INCLUDES:

- .125 (3.2) Dia. Armor Wrap Core
- .44 (11.2) Dia. Conduit
- 3" or 5" Travel @ Handle End
- 2", 3", 4" or 5" Travel @ Swivel End

| Swivel End Dimensions | | |
|-----------------------|---------------------------|--------------------------|
| Travel (Output End) | Bulkhead Type Fitting "A" | Grooved Type Fitting "B" |
| 2" (50.8) | 7.13 (181.1) | 6.50 (165.1) |
| 3" (76.2) | 9.13 (231.9) | 8.50 (215.9) |
| 4" (101.6) | 11.13 (282.7) | 10.50 (266.5) |
| 5" (127.0) | 13.13 (333.5) | 12.50 (317.5) |

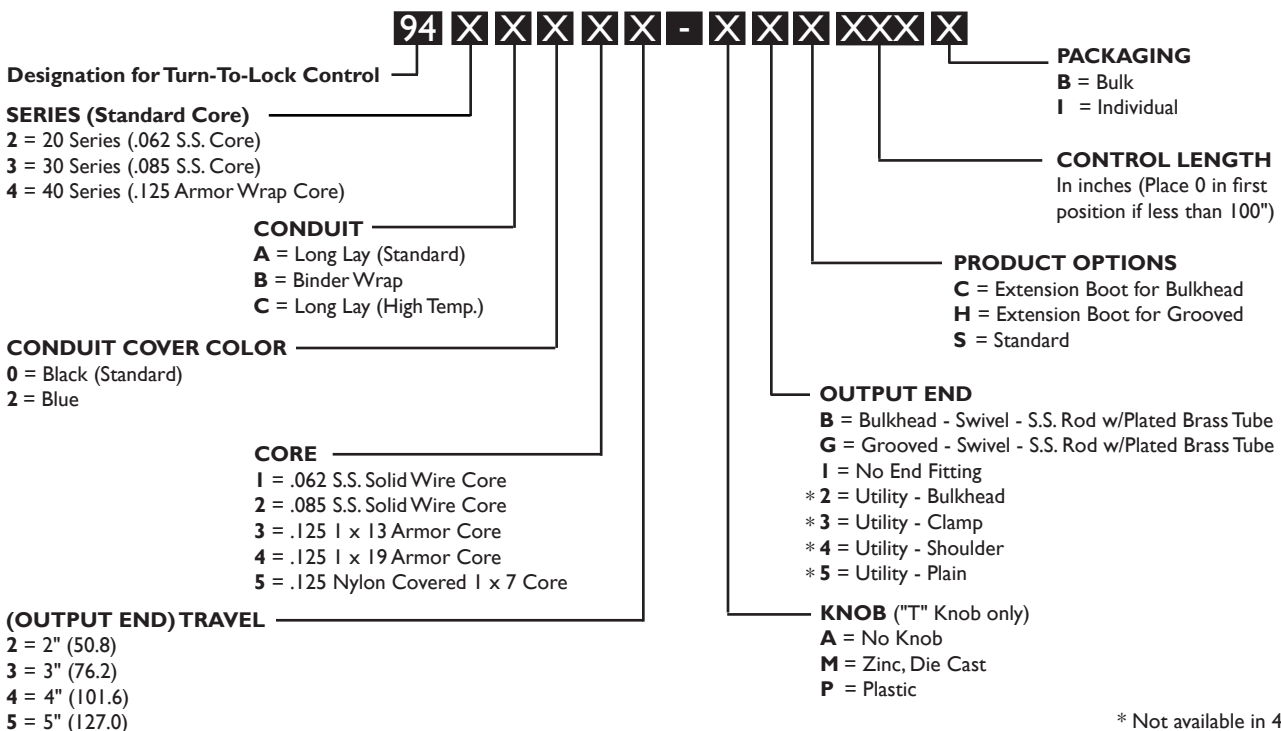
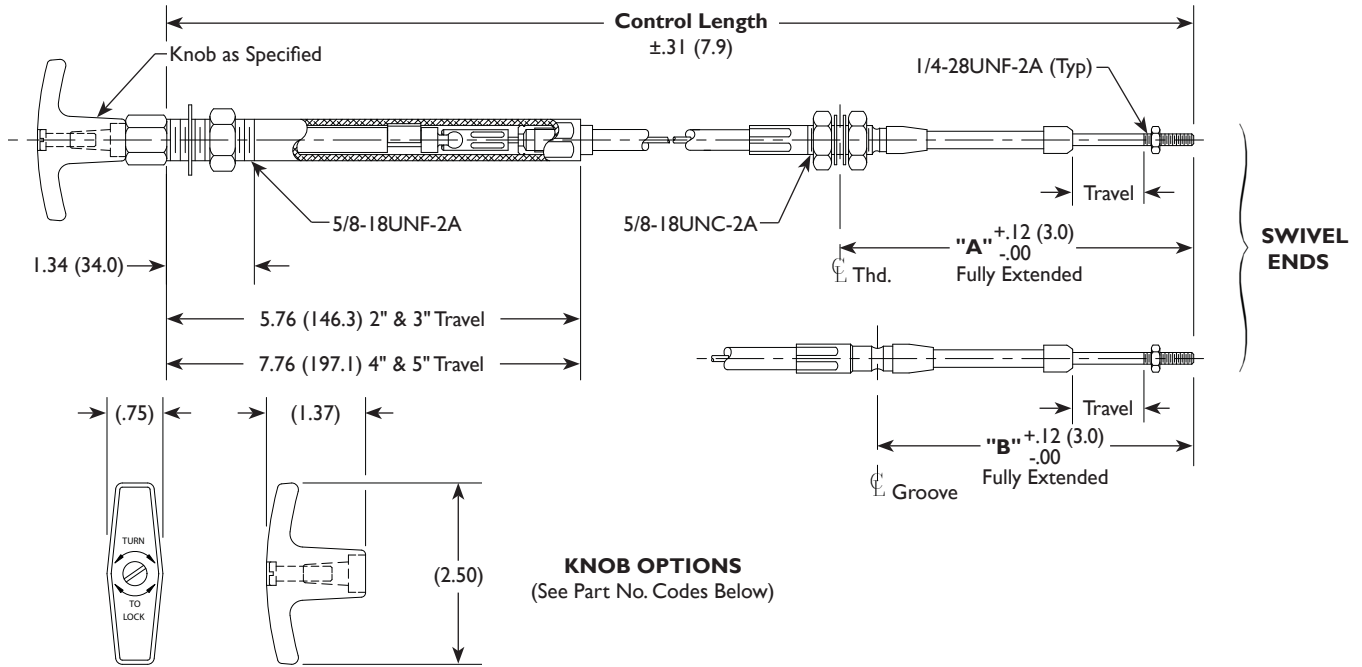

* Not available in 40 Series

20 SERIES CONTROL

STANDARD CONSTRUCTION INCLUDES:

- .062 (1.6) Dia. Stainless Steel Wire
- .25 (6.4) Dia. Conduit
- 2", 3" or 5" Travel @ Handle End
- 2", 3", 4" or 5" Travel @ Swivel End

30 SERIES CONTROL

STANDARD CONSTRUCTION INCLUDES:

- .085 (2.2) Dia. Stainless Steel Wire
- .31 (7.9) Dia. Conduit
- 3" or 5" Travel @ Handle End
- 2", 3", 4" or 5" Travel @ Swivel End
- 30 Series is Wescon's standard Non-Locking Control System

These controls are designed for smooth and easy hand actuated remote operation of valves, chokes, throttles and shut-offs.

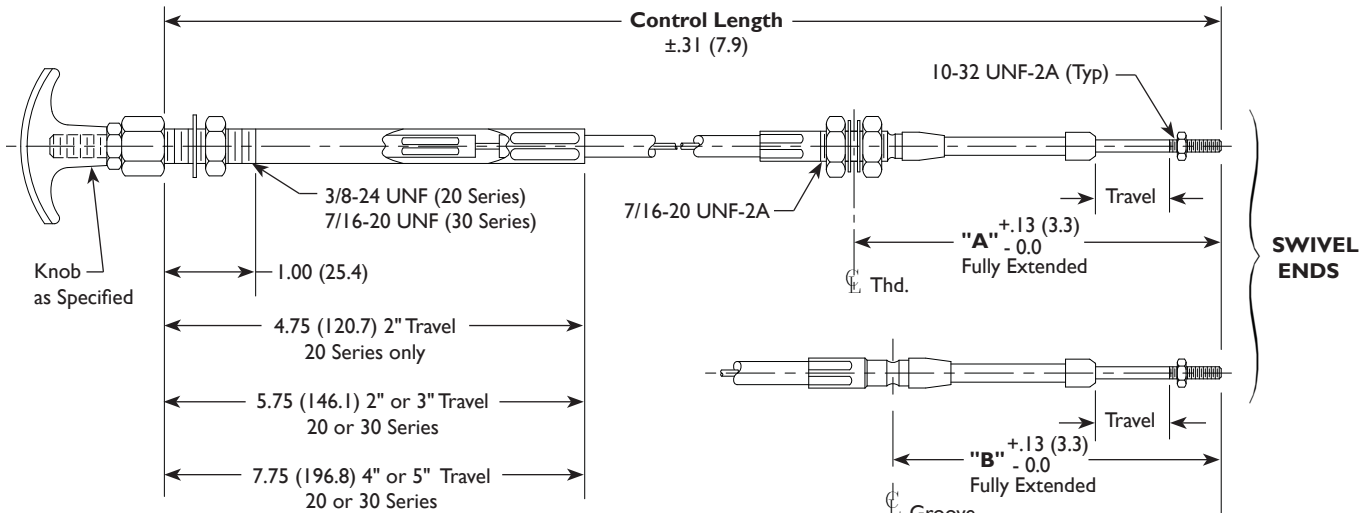

KNOB OPTIONS

(See Part No. Codes Pg. 12)

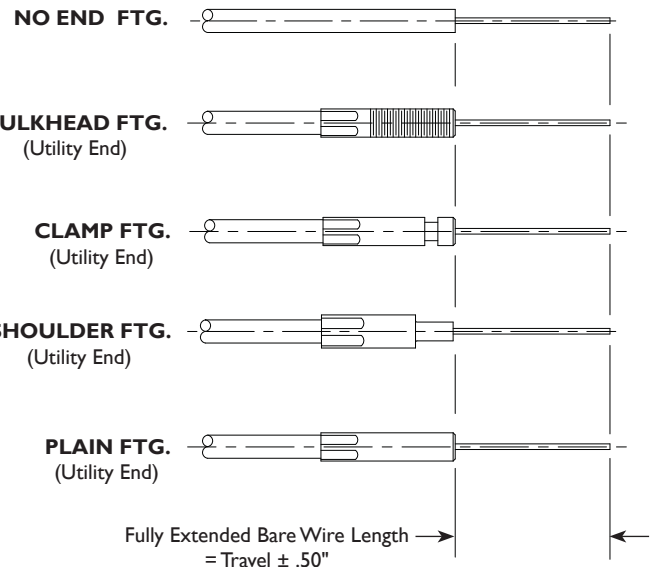
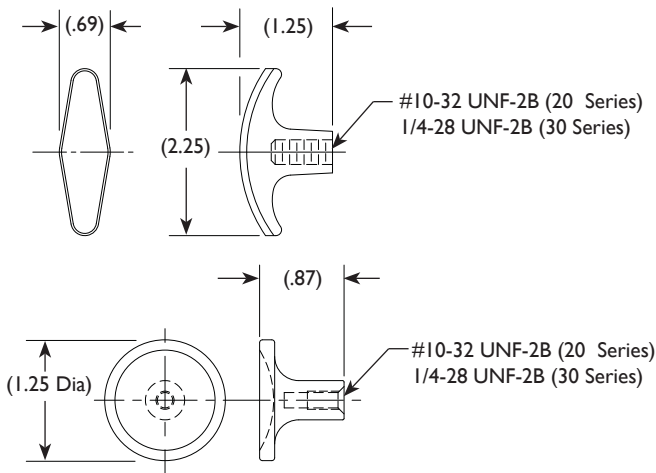

UTILITY ENDS

Field installed fitting kits are available for Utility Ends for 30 series conduit sizes only. See Pg. 13 for details and dimensions.

| Swivel End Dimensions | | |
|-----------------------|---------------------------|--------------------------|
| Travel (Output End) | Bulkhead Type Fitting "A" | Grooved Type Fitting "B" |
| 2" (50.8) | 6.87 (174.5) | 6.31 (160.3) |
| 3" (76.2) | 8.88 (225.6) | 8.30 (210.8) |
| 4" (101.6) | 10.87 (276.1) | 10.31 (261.9) |
| 5" (127.0) | 12.88 (327.1) | 12.30 (312.4) |

All Dimensions are Inches (mm)

40 SERIES CONTROL

STANDARD CONSTRUCTION INCLUDES:

- .125 (3.2) Dia. Armor Wrap Core
- .44 (11.2) Dia. Conduit
- 3" or 5" Travel @ Handle End
- 2", 3", 4" or 5" Travel @ Swivel End

| Swivel End Dimensions | | |
|-----------------------|---------------------------|--------------------------|
| Travel (Output End) | Bulkhead Type Fitting "A" | Grooved Type Fitting "B" |
| 2" (50.8) | 7.13 (181.1) | 6.50 (165.1) |
| 3" (76.2) | 9.13 (231.9) | 8.50 (215.9) |
| 4" (101.6) | 11.13 (282.7) | 10.50 (266.5) |
| 5" (127.0) | 13.13 (333.5) | 12.50 (317.5) |

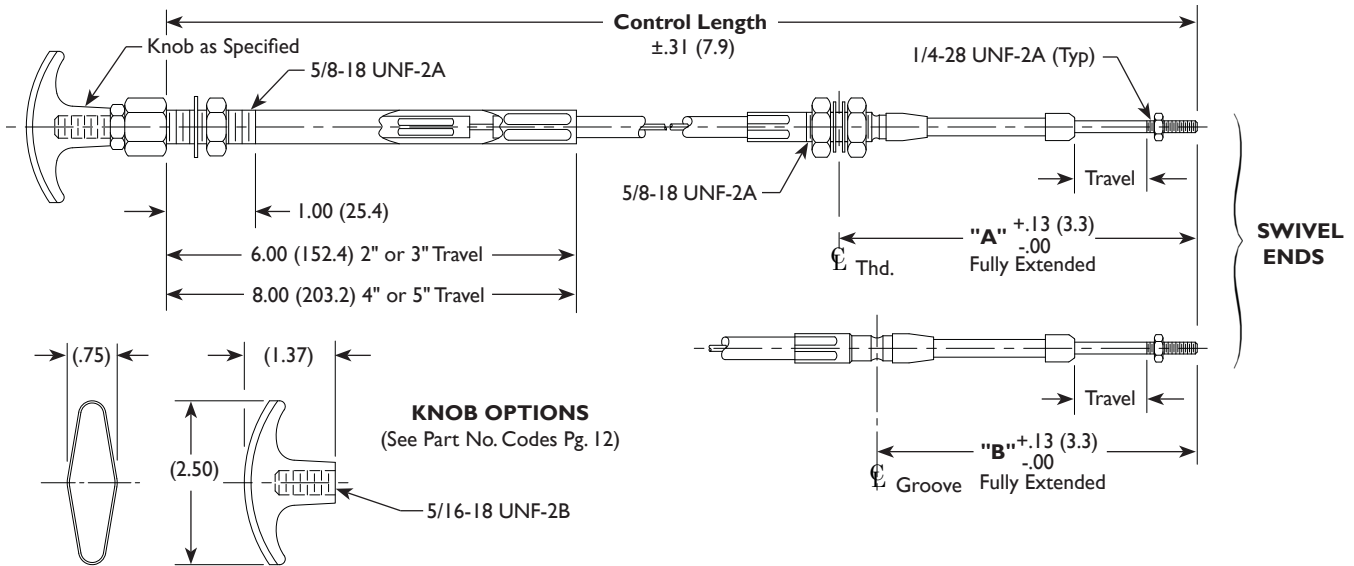

60 SERIES CONTROL

STANDARD CONSTRUCTION INCLUDES:

- .187 (4.7) Dia. Armor Wrap Core
- .44 (11.2) Dia. Conduit
- 3" Travel @ Handle End
- 1", 2" or 3" Travel @ Swivel End

| Swivel End Dimensions | | |
|-----------------------|---------------------------|--------------------------|
| Travel (Output End) | Bulkhead Type Fitting "A" | Grooved Type Fitting "B" |
| 1" (25.4) | 5.56 (141.2) | 4.88 (123.9) |
| 2" (50.8) | 7.56 (192.0) | 6.88 (174.7) |
| 3" (76.2) | 9.56 (242.8) | 8.88 (225.6) |

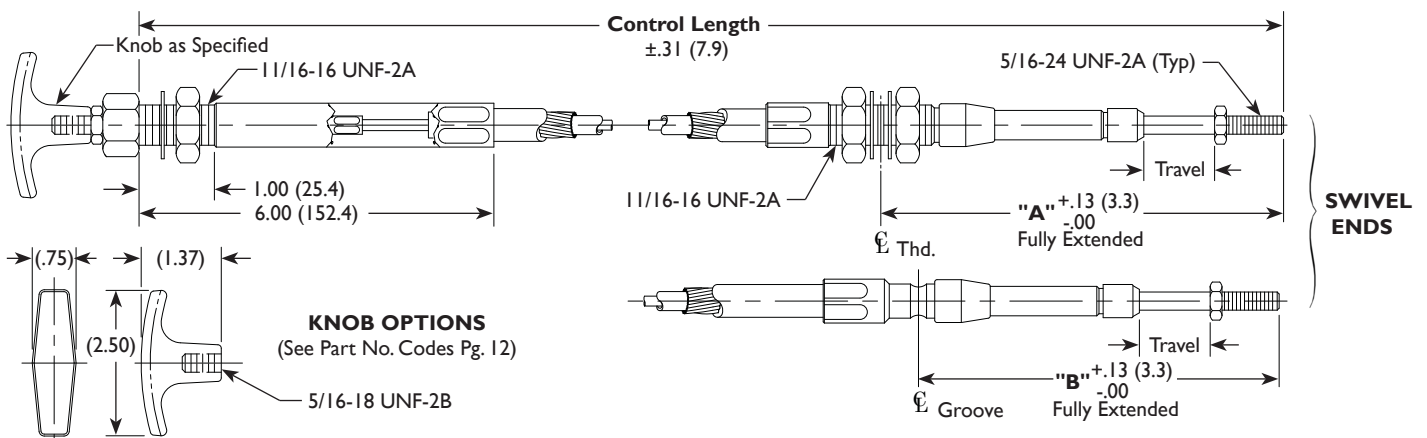

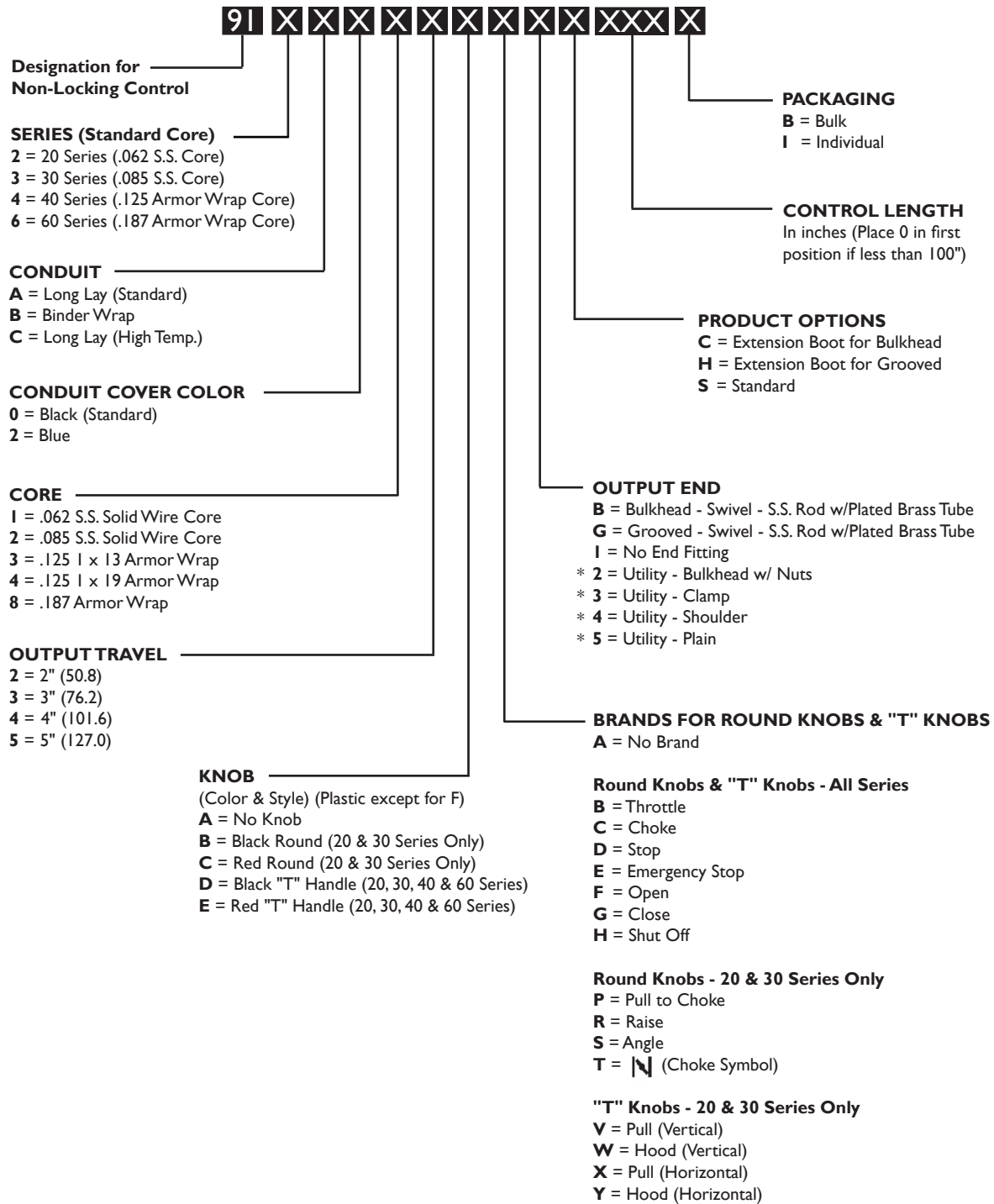

* Not available in 40 Series

All panel controls may be ordered with "No End Ftg." as shown on pages 6, 8 and 10. Utility end fittings are available for 30 series conduit only. These fittings are designed to be installed in the field using standard tools across the hex feature of the fittings.

Kit consists of fitting (as shown) along with felt seal, 2 jam nuts and instruction sheet.

Bulkhead Fitting

| |
|-----------------|
| Kit Part Number |
| 01-5000-05 |

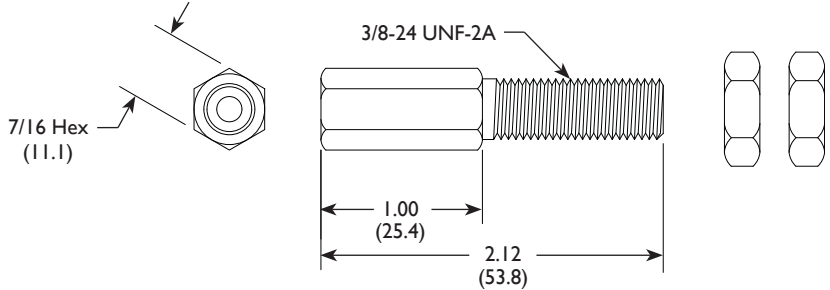

Clamp Fitting

| |
|-----------------|
| Kit Part Number |
| 01-5000-06 |

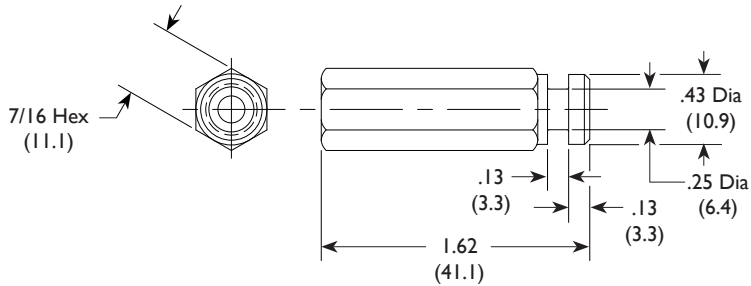

Shoulder Fitting

| |
|-----------------|
| Kit Part Number |
| 01-5000-07 |

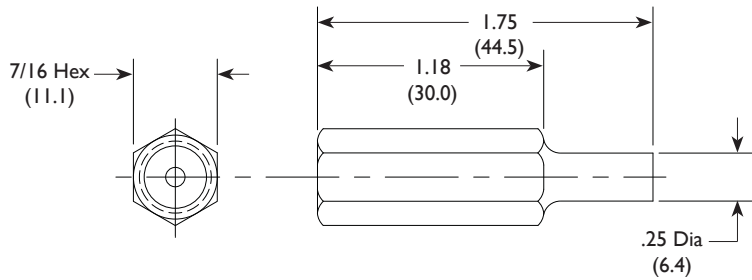

Plain Fitting

| |
|-----------------|
| Kit Part Number |
| 01-5000-08 |

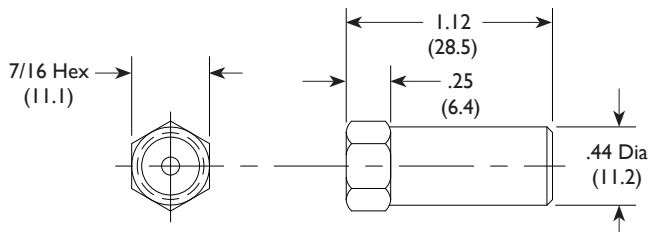

U-Bolt Assembly

| |
|------------------|
| 40 and 60 Series |
| Part Number |
| 01-5000-14 |

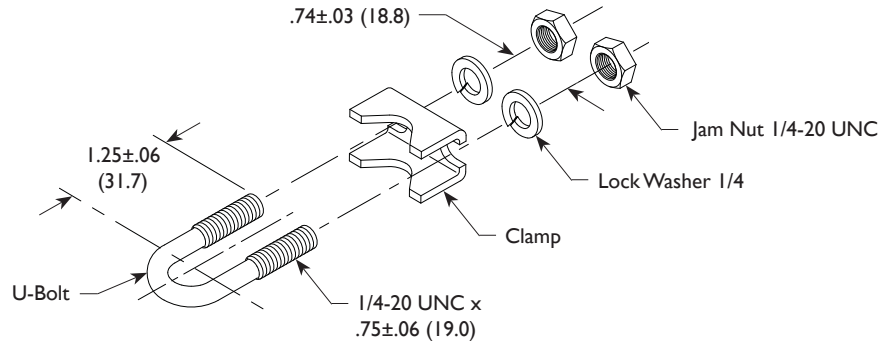

Brackets

| 30 Series | | | | | | |
|-------------|-------------|-----------|------------|-------------|------------|------------|
| Part Number | "A" Dia | "B" | "C" | "D" | "E" | "F" |
| 08-0008-01 | .281 (7.1) | .38 (9.6) | .62 (15.7) | 1.29 (32.8) | .272 (6.9) | .62 (15.7) |
| 08-0008-02 | .406 (10.3) | .38 (9.6) | .62 (15.7) | 1.29 (32.8) | .272 (6.9) | .62 (15.7) |

All Dimensions are Inches (mm)

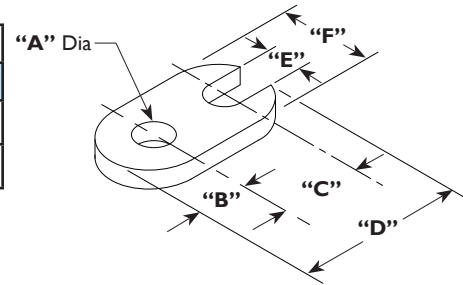

Clamps

| 20 and 30 Series | | | | |
|------------------|------------|-------------|-------------|------------|
| Part Number | "A" | "B" | "C" | "D" Dia |
| 08-0009-01 | .50 (12.7) | 1.50 (38.1) | 1.00 (25.4) | .203 (5.1) |
| 40 Series | | | | |
| 08-0009-02 | .50 (12.7) | 1.50 (38.1) | 1.00 (25.4) | .218 (5.5) |

All Dimensions are Inches (mm)

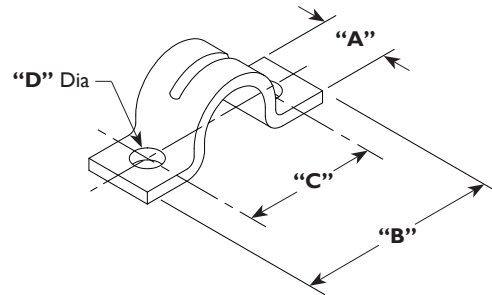

Shim

| 20 and 30 Series | | | | |
|------------------|------------|-------------|-------------|------------|
| Part Number | "A" | "B" | "C" | "D" Dia |
| 08-0010-01 | .50 (12.7) | 1.50 (38.1) | 1.00 (25.4) | .203 (5.1) |
| 40 Series | | | | |
| 08-0010-02 | .50 (12.7) | 1.50 (38.1) | 1.00 (25.4) | .218 (5.5) |

All Dimensions are Inches (mm)

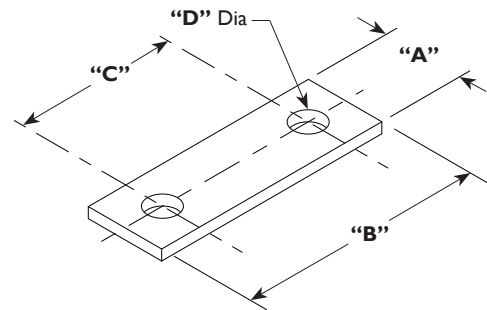

Ball Joint

| 20 and 30 Series | | | | |
|------------------|---------|------------|------------|------------|
| Part Number | "A" Thd | "B" | "C" | "D" |
| 08-0005-01 | 1/4-28 | .47 (11.9) | .56 (14.2) | .91 (23.1) |
| 08-0005-02 | 10-32 | .47 (11.0) | .44 (11.2) | .91 (23.1) |
| 40 Series | | | | |
| 08-0004-01 | 1/4-28 | .50 (12.7) | .56 (14.2) | .97 (24.6) |

All Dimensions are Inches (mm)

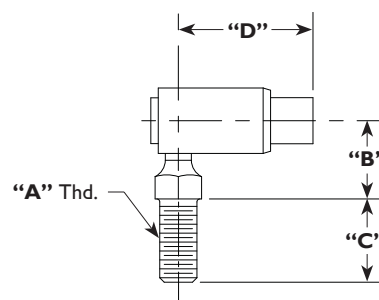

Wire Stop Assembly

| Part Number | "A" Dia | "B" Hex |
|-------------|------------|-------------|
| 13-0404-01 | .110 (2.8) | 5/16 (7.9) |
| 13-0404-02 | .144 (3.7) | 5/16 (7.9) |
| 13-0404-03 | .22 (5.2) | 7/16 (10.9) |

All Dimensions are Inches (mm)

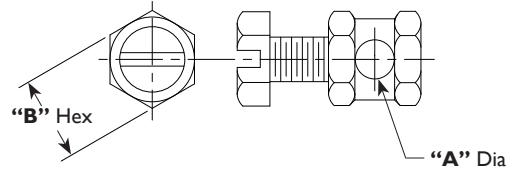

Pivot

| 20 and 30 Series (#10-32 Thread) | | | | | | |
|----------------------------------|------|------|------|---------|---------|---------|
| Part Number | "A" | "B" | "C" | "D" Dia | "E" Dia | "F" Dia |
| 02-1601-01 | .718 | .375 | .611 | .187 | .081 | .43 |
| 02-1601-02 | .625 | .315 | .496 | .250 | .081 | .43 |
| 02-1601-03 | .781 | .310 | .645 | .250 | .081 | .43 |
| 02-1601-06 | .750 | .380 | .656 | .230 | .093 | .43 |
| 40 Series (1/4-28 Thread) | | | | | | |
| 02-1601-04 | .906 | .562 | .743 | .312 | .081 | .50 |

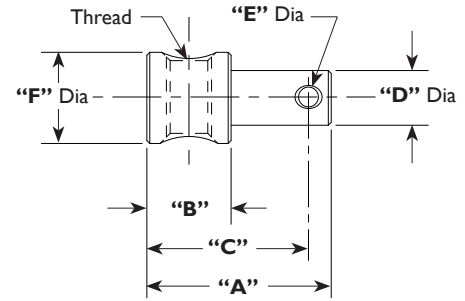

Swivel Assembly

| Part Number | "A" Dia | "B" |
|-------------|------------|------------|
| 13-0403-00 | .104 (2.6) | .194 (4.9) |

All Dimensions are Inches (mm)

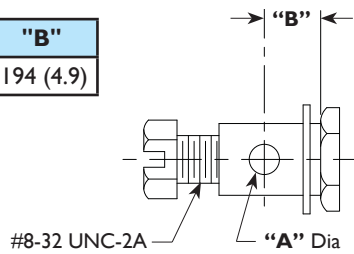

Wire Stop Kit

| Part Number |
|-------------|
| 01-5000-74 |

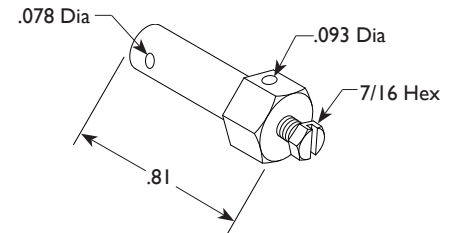

Clevis Assembly

| 20 and 30 Series (10-32 Thread) | | | | |
|---------------------------------|------------|-------------|-------------|-------------|
| Part Number | "A" Dia | "B" | "C" | "D" |
| 06-1500-04 | .187 (4.8) | 1.56 (39.7) | 1.00 (25.4) | .187 (4.8) |
| 06-1500-05 | .25 (6.3) | 2.00 (50.8) | 1.25 (31.7) | .281 (7.1) |
| 40 Series (1/4-28 Thread) | | | | |
| 06-1500-01 | .25 (6.4) | 2.00 (50.8) | 1.25 (31.8) | .281 (7.1) |
| 06-1500-02 | .31 (7.9) | 2.25 (57.2) | 1.44 (36.5) | .343 (8.7) |
| 06-1500-03 | .38 (9.5) | 2.50 (63.5) | 1.62 (41.3) | .437 (11.1) |

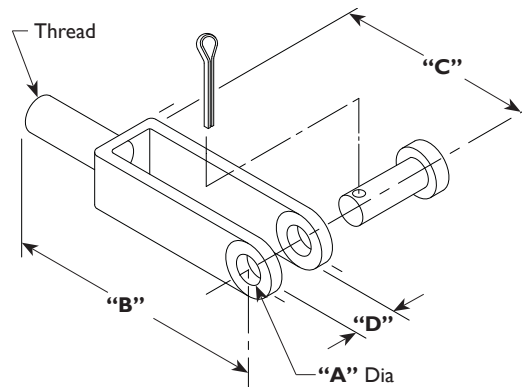

Conduit Clamp Kit

Designed for mounting PTO or 30 Series Controls only.

| Part Number |
|-------------|
| 01-5000-09 |

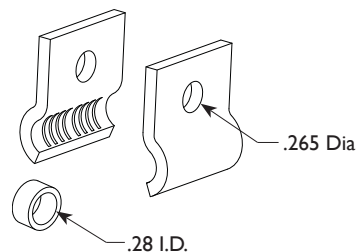

TAKE A LOOK AT OTHER WESCON PRODUCTS



Remote Valve Control Systems

Look to Wescon for your remote valve applications. Wescon's Remote Valve Control (RVC) has been engineered to place versatility in the hands of the installer. Our center or end-locking feature, thumb activated by the "Big Red Button", can help your system meet OSHA Standards. We also offer options such as bent levers to fit your mounting requirements, electric switches installed in the lever or an adjustable friction device to "customize" your lever resistance. A wide selection of control heads, conduit, connection hardware kits and mounting systems makes it easy to choose Wescon for your RVC application.



Brake Cable and Lever Systems

Welded construction and zinc plating are incorporated in every Wescon brake lever for stamina and quality assurance. Optional adjustment lock-down screws and zinc plated/yellow chromate dipped cable connection hardware kits are also available.

Wescon brake cables are built with a conduit construction that allows high loads to be carried with low compressive deflection. All linings and coverings are formulated to reduce friction, abrasion, contamination and ultimately maximize efficiency.

Consult your Wescon representative for proper applications and recommendations.

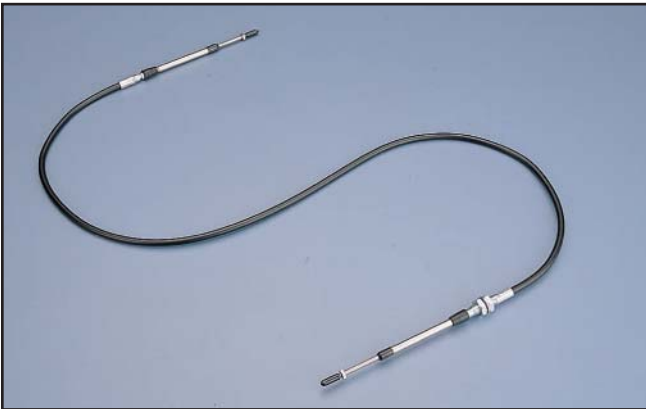

Push-Pull Cables Control Systems

Proven technology and years of experience have gone into making the Wescon push-pull cables top of the line in durability and dependability. Polyethylene covers and a variety of conduit constructions can be customized to fit your specific cable usage. Other optional plastics or nylon can be added to suit your environmental, corrosion resistant or extreme temperature applications.



Light Duty Cable Control Systems

Our light duty cable control systems are engineered to help your equipment run smoother while complementing the functionality and the aesthetics of your product. Call the Wescon team to help you design controls that add to the marketability of your products.



ISO 9001 CERTIFIED

WESCON CONTROLS

P.O. Box 7710 Wichita, Kansas 67277

316-942-7266 or call toll free 1-800-835-0160

Fax 316-942-5114

www.wesconproducts.com